



More of what you need to work smarter, faster, and better. Visit www.parkerhose.com for up-to-the-minute accessory selections.













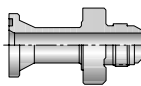
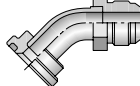
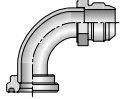
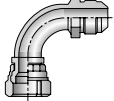

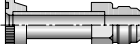
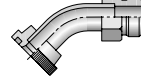
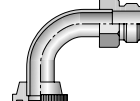
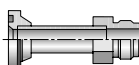
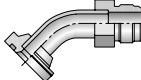
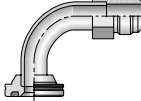

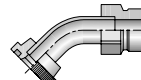
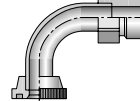
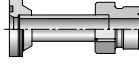
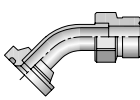
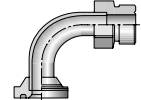
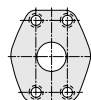
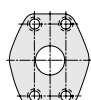
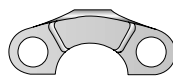

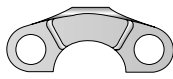



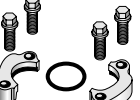

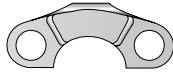
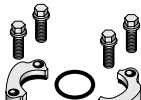
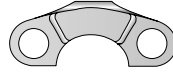

Accessories

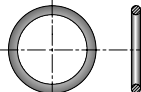
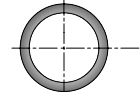

D

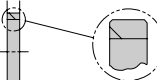

ENGINEERING YOUR SUCCESS.

A
B
C
D
E

	Hose Adapters D4 		15T3 D-5  Code 61 - JIC 37°	17T3 D-5  Code 61 - JIC 37° 45° Elbow	19T3 D-5  Code 61 - JIC 37° 90° Elbow
39T3 D-6  Male - Female JIC 37° - 90° Elbow	41T3 D-6  Male - Female JIC 37° 90° Elbow - Long	4AH3 D-6  Code 61 - JIC 37° 5000 psi	4FH3 D-7  Code 61 - JIC 37° 5000 psi - 45° Elbow	4NH3 D-7  Code 61 - JIC 37° 5000 psi - 90° Elbow	6AH3 D-7  Code 62 - JIC 37°
6FH3 D-7  Code 62 - JIC 37° 45° Elbow	6NH3 D-8  Code 62 - JIC 37° 90° Elbow	4AJM D-8  Code 61 - Seal-Lok®	4FJM D-8  Code 61 - Seal-Lok® 45° Elbow	4NJM D-8  Code 61 - Seal-Lok® 90° Elbow	6AJM D-9  Code 62 - Seal-Lok®
6FJM D-9  Code 62 - Seal-Lok® 45° Elbow	6NJM D-9  Code 62 - Seal-Lok® 90° Elbow	Standard Pressure (Code 61) Specifications D-10 	High Pressure (Code 62) Specifications D-10 	50H D-10  Flange Half 5000 psi (Code 61)	5050HK D-11  Flange Kit Code 61 - 5000 psi
51H D-11  Flange Half - Code 61	5151HK D-11  Flange Kit - Code 61	HFH D-12  Flange Half - Code 62	HFHFHK D-12  Flange Kit - Code 62	8FH D-12  Flange Half 8000 psi	8FHFHK D-12  Flange Kit 8000 psi
FFK61 D-13  Full Flange Kit	M1H D-14  Flange Half ISO - Code 61	M1M1HK D-14  Flange Kit ISO - Code 61	M2H D-15  Flange Half ISO - Code 62	M2M2HK D-15  Flange Kit ISO - Code 62	XCXCHK D-15  Flange Kit - CAT
	711509 D-16  O-Rings SAE Thread	711510 D-16  O-Rings Code 61/Code 62	C9RG D-16  O-Rings for CA, CE, CF Metric	C9RG D-16  O-Rings for C9, OC, 1C Metric Swivels	D9DT D-16  Bonded Seal for BSP Port Fittings
J0RG D-17  O Rings - Seal-Lok®	XARG D-17  Flange "D" Rings CAT	8ARG D-17  Flange "D" Rings 76 Series	59RG D-18  O-Rings - Tube O- Ring & Compressor Fittings	T1RG D-18  O-Rings Compression Fittings (IT126)	CORG D-18  O-Ring Assembly Tools

 <p>Hose Guards</p>	<p>Partek Defense D-19</p> 	<p>Partek Wrap D-20</p> 	<p>Partek Sleeve D-21</p> 	<p>PolyGuard (HG) D-22</p> 	<p>ParKoil™ (PG) D-22</p> 
<p>Spring Guard (SG) D-23 Armor Guard (AG)</p> 	<p>Polyguard Strain Reliever D-23</p> 	<p>Hose Whip Restraint D-24</p> 	<p>Firesleeve (FS-F) D-25</p> 	<p>FSC Clamp D-25</p> 	<p>Firesleeve Assembly Instructions D-26</p> 
<p>CL Clamp D-27</p> 	<p>HC Clamp D-28</p> 	<p>88HC-H Wormgear D-28</p> 	<p>88DB Clamp D-28</p> 	<p>Protection Shields D-29</p> 	 <p>Hose Assembly Workstations</p>
<p>Hose Assembly Workstations D-30</p> 	<p>HoseFab Table D-31</p> 	<p>Rotary Reel Rack D-31</p> 	<p>Saw Table D-31</p> 	<p>3/4 Reel Rack D-31</p> 	<p>Parker Kart D-32</p> 
<p>72B-Cabinet D-32</p> 	<p>HR6 Hose Bin D-32</p> 				

- A
- B
- C
- D
- E



SAE/NPT/Metric Hose Adapters

A



O-Ring Face-Seal Seal-Lok™

Sizes: 6 mm – 38 mm
Materials: Steel, Stainless Steel
Pressures: Up to 9200 psi

O-Ring Face-Seal Metric Seal-Lok™

Sizes: 1/4" – 2"
Materials: Steel, Stainless Steel
Pressures: Up to 9200 psi

37° Flare Fittings Triple-Lok®

Sizes: 1/8" – 2"
Materials: Steel, Stainless Steel, Brass
Pressures: Up to 9000 psi

37° Flare Metric Triple-Lok®

Sizes: 6 mm – 38 mm
Materials: Steel, Stainless Steel
Pressures: Up to 7200 psi

Pipe Fittings and Port Adapters

Sizes: 1/8" – 2"
Materials: Steel, Stainless Steel, Brass
Pressures: Up to 7200 psi

Conversion Adapters

Sizes: 1/4" – 1-1/2"
Materials: Steel, Stainless Steel
Pressures: Up to 7700 psi

B



Pipe Swivels

Sizes: 1/8" – 2"
Materials: Steel, Stainless Steel
Pressures: Up to 5000 psi

Hydraulic Flange and Flange Adapters

Sizes: 3/4" – 3"
Materials: Steel, Stainless Steel
Pressures: Up to 6000 psi

Japanese Industrial Standard JIS

Sizes: 1/4" – 1"
Materials: Steel
Pressures: Up to 5000 psi

30° Flare Komatsu Style

Sizes: M14 x 1.5 – M33 x 1.5
Materials: Steel
Pressures: Up to 4000 psi

60° Cone BSPP K4

Sizes: 1/8" – 2"
Materials: Steel
Pressures: Up to 5000 psi

C

D

How to Order Parker Hose Adapters

When ordering Parker Adapters, please state the Catalogued Number of each type of adapter desired. Be sure to double check tube and hose sizes of items required.

Note: Refer to **Parker Catalog 4300** for more detailed application information.

To select proper seal materials for specific applications, refer to Media Compatibility Chart in Tube Fitting Catalog 4300, or contact your Parker Tube Fitting Distributor.

CALL TOLL-FREE 1-800-C PARKER (1-800-272-7537)

If in doubt about which type or size of fitting to specify, consult your Parker Tube Fitting Distributor. In addition Parker Field Sales, Technical Services, the Tube Fitting Division and your local Parker Service Center will help you find answers to all your issues.

Parker Information Center for catalogs, literature or additional information.

Phone: (614) 279-7070
Fax: (614) 279-7685
Web: <http://www.parker.com/tfd>



15T3

SAE (Code 61) Flange – Male SAE (JIC) 37° Flare

# Part Number	Flange inch	Thread T1		A		W inch	F inch
		inch	mm	inch	mm		
15T3-8-8	1/2	1/2	3/4x16	2.80	71	1-1/4	1-3/16
15T3-12-12	3/4	3/4	1-1/16x12	3.20	81	1-9/16	1-1/2
15T3-16-12	1	3/4	1-1/16x12	2.68	47	1-1/8	1-3/4
15T3-16-16	1	1	1-5/16x12	3.22	82	1-7/8	1-3/4
15T3-20-16	1-1/4	1	1-5/16x12	2.76	51	1-3/8	2
15T3-20-20	1-1/4	1-1/4	1-5/8x12	3.69	94	2-1/4	2
15T3-24-24	1-1/2	1-1/2	1-7/8x12	4.04	103	2-1/2	2-3/8
15T3-32-32	2	2	2-1/2x12	4.44	113	2-7/8	2-13/16

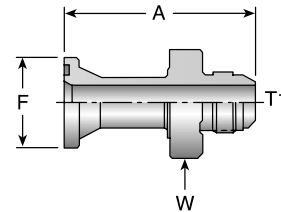

A

17T3

SAE (Code 61) Flange – Male SAE (JIC) 37° Flare - 45° Elbow

# Part Number	Flange inch	Thread T1		A		E		W inch	F inch
		inch	mm	inch	mm	inch	mm		
17T3-8-8	1/2	1/2	3/4x16	2.54	65	0.78	20	13/16	1-3/16
17T3-12-12	3/4	3/4	1-1/16x12	2.76	70	1.00	25	1-9/16	1-1/2
17T3-16-12	1	3/4	1-1/16x12	2.76	70	1.00	25	1-1/8	1-3/4
17T3-16-16	1	1	1-5/16x12	2.99	76	1.06	27	1-3/8	1-3/4
17T3-20-16	1-1/4	1	1-5/16x12	2.99	76	1.06	27	1-7/8	2
17T3-20-20	1-1/4	1-1/4	1-5/8x12	3.22	82	1.12	28	1-11/16	2
17T3-24-20	1-1/2	1-1/4	1-5/8x12	3.26	83	1.17	30	1-11/16	2-3/8
17T3-24-24	1-1/2	1-1/2	1-7/8x12	3.43	87	1.12	28	2	2-3/8
17T3-32-32	2	2	2-1/2x12	4.02	102	1.25	32	2-5/8	2-13/16

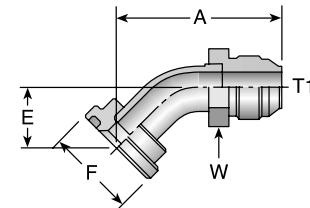

B

C

19T3

SAE (Code 61) Flange – Male SAE (JIC) 37° Flare - 90° Elbow

# Part Number	Flange inch	Thread T1		A		E		W inch	F inch
		inch	mm	inch	mm	inch	mm		
19T3-8-8	1/2	1/2	3/4x16	1.92	49	1.62	41	13/16	1-13/16
19T3-12-12	3/4	3/4	1-1/16x12	2.46	62	2.12	54	1-1/8	1-1/2
19T3-16-12	1	3/4	1-1/16x12	2.46	62	2.12	54	1-3/8	1-3/4
19T3-20-12	1-1/4	3/4	1-1/16x12	2.46	62	2.12	54	1-3/8	2
19T3-16-16	1	1	1-5/16x12	2.79	71	2.37	60	1-3/8	1-3/4
19T3-20-16	1-1/4	1	1-5/16x12	2.79	71	2.37	60	1-3/8	2
19T3-24-16	1-1/2	1	1-5/16x12	2.79	71	2.44	62	1-11/16	2-3/8
19T3-20-20	1-1/4	1-1/4	1-5/8x12	3.12	79	2.50	64	1-11/16	2
19T3-24-20	1-1/2	1-1/4	1-5/8x12	3.12	79	2.56	65	1-11/16	2-3/8
19T3-20-24	1-1/4	1-1/2	1-7/8x12	3.48	88	2.69	68	2	2
19T3-24-24	1-1/2	1-1/2	1-7/8x12	3.48	88	2.75	70	2	2-3/8
19T3-32-24	2	1-1/2	1-7/8x12	3.48	88	2.75	70	2	2-13/16
19T3-32-32	2	2	2-1/2x12	5.61	142	4.50	114	2-5/8	2-13/16

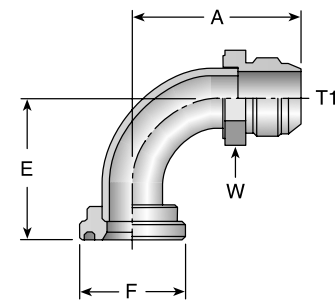

D

E

Caution: Do not use the T3 flange to tube or swivel nut to tube adapter in hose assembly applications in which pressures exceed the SAE100R2 working pressure range.



39T3

Male - Female Swivel - SAE (JIC) 37° - 90° Elbow

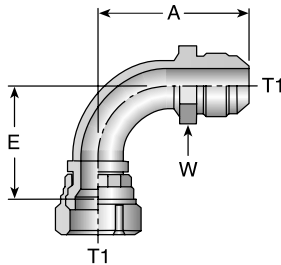

# Part Number	Thread		A		E		W
	inch	mm	inch	mm	inch	mm	inch
39T3-6-6	3/8	9/16x18	1.61	41	0.85	22	5/8
39T3-8-8	1/2	3/4x16	1.86	47	1.09	28	13/16
39T3-10-10	5/8	7/8x14	2.13	54	1.24	31	15/16
39T3-12-12	3/4	1-1/16x12	2.62	67	1.81	46	1-1/8
39T3-16-16	1	1-5/16x12	2.94	75	2.14	54	1-3/8
39T3-20-20	1-1/4	1-5/8x12	3.12	79	2.59	66	1-11/16

41T3

Male - Female Swivel - SAE (JIC) 37° - 90° Elbow - Long

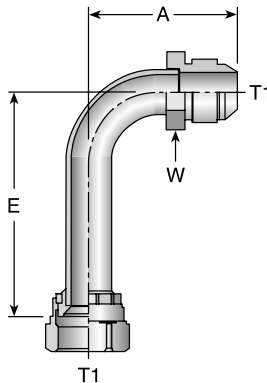

# Part Number	Thread		A		E		W
	inch	mm	inch	mm	inch	mm	inch
41T3-8-8	1/2	3/4x16	1.94	49	2.43	62	13/16
41T3-10-10	5/8	7/8x14	2.20	56	2.57	65	15/16
41T3-12-12	3/4	1-1/16x12	2.50	64	3.74	95	1-1/8
41T3-16-16	1	1-5/16x12	2.79	71	4.23	107	1-3/8

4AH3

SAE Code 61 Flange - Male SAE (JIC) 37° Flare - 5000 psi

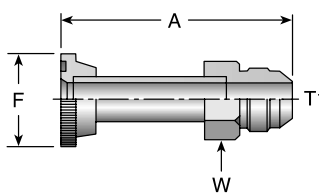

# Part Number	Flange	Thread		A		W	F
	inch	inch	mm	inch	mm	inch	inch
4AH3-12-12	3/4	3/4	1-1/16x12	3.82	97	1-1/8	1-1/2
4AH3-16-16	1	1	1-5/16x12	4.09	104	1-3/8	1-3/4
4AH3-20-20	1-1/4	1-1/4	1-5/8x12	4.16	106	1-3/4	2
4AH3-24-24	1-1/2	1-1/2	1-7/8x12	4.97	126	2	2-3/8

Caution: Do not use the T3 flange to tube or swivel nut to tube adapter in hose assembly applications in which pressures exceed the SAE100R2 working pressure range.

4FH3

SAE Code 61 Flange - Male SAE (JIC) 37° Flare - 5000 psi - 45° Elbow

# Part Number	Flange inch	Thread		A		E		W inch	F inch
		T1		inch	mm	inch	mm		
4FH3-12-12	3/4	3/4	1-16x12	3.39	86	1.06	27	1-1/8	1-1/2
4FH3-16-16	1	1	1-5/16x12	3.85	98	1.27	32	1-3/8	1-3/4
4FH3-20-20	1-1/4	1-1/4	1-5/8x12	4.22	107	1.36	35	1-3/4	2

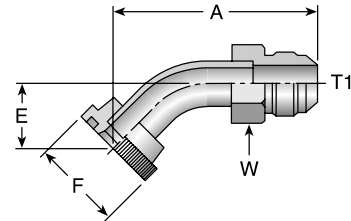

4NH3

SAE Code 61 Flange - Male SAE (JIC) 37° Flare - 5000 psi - 90° Elbow

# Part Number	Flange inch	Thread		A		E		W inch	F inch
		T1		inch	mm	inch	mm		
4NH3-8-8	1/2	1/2	3/4x16	1.93	49	1.68	43	13/16	1-13/16
4NH3-12-12	3/4	3/4	1-1/16x12	3.07	78	2.24	57	1-1/8	1-1/2
4NH3-16-16	1	1	1-5/16x12	3.25	83	2.48	63	1-3/8	1-3/4
4NH3-20-20	1-1/4	1-1/4	1-5/8x12	4.68	119	2.99	76	1-3/4	2
4NH3-24-24	1-1/2	1-1/2	1-7/8x12	3.92	100	3.64	92	2	2-3/8

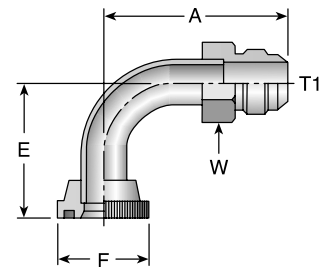

6AH3

SAE Code 62 Flange - Male SAE (JIC) 37° Flare

# Part Number	Flange inch	Thread		A		W inch	F inch
		T1		inch	mm		
6AH3-12-12	3/4	3/4	1-1/16x12	3.82	97	1-1/8	1-5/8
6AH3-16-16	1	1	1-5/16x12	4.09	104	1-3/8	1-7/8
6AH3-20-20	1-1/4	1-1/4	1-5/8x12	4.16	106	1-3/4	2-1/8
6AH3-24-24	1-1/2	1-1/2	1-7/8x12	4.97	126	2	2-1/2

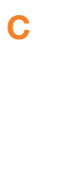
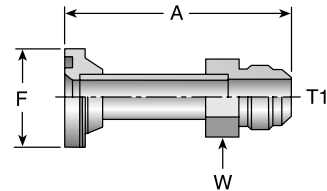

6FH3

SAE Code 62 Flange - Male SAE (JIC) 37° Flare - 45° Elbow

# Part Number	Flange inch	Thread		A		E		W inch	F inch
		T1		inch	mm	inch	mm		
6FH3-12-12	3/4	3/4	1-1/16x12	3.40	86	1.06	27	1-1/8	1-5/8
6FH3-16-16	1	1	1-5/16x12	3.85	98	1.28	33	1-3/8	1-7/8
6FH3-20-20	1-1/4	1-1/4	1-5/8x12	4.22	107	1.36	35	1-3/4	2-1/8
6FH3-24-24	1-1/2	1-1/2	1-7/8x12	5.13	130	1.71	43	2	2-1/2

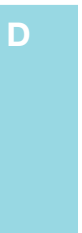
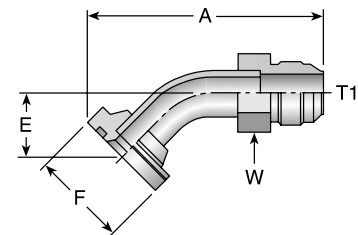

6NH3

SAE Code 62 Flange - Male SAE (JIC) 37° Flare - 90° Elbow

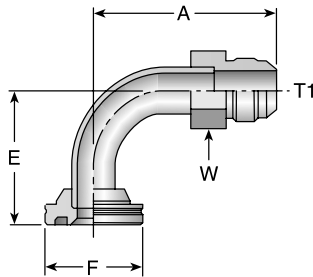

# Part Number	Flange		Thread		A		E		W	F
	inch		T1		inch	mm	inch	mm	inch	inch
6NH3-12-12	3/4	3/4	1-1/16x12		3.07	78	2.24	57	1-1/8	1-5/8
6NH3-16-16	1	1	1-5/16x12		3.58	91	2.81	71	1-3/8	1-7/8
6NH3-20-20	1-1/4	1-1/4	1-5/8x12		4.68	119	2.99	76	1-3/4	2-1/8
6NH3-24-24	1-1/2	1-1/2	1-7/8x12		3.92	100	3.64	92	2	2-1/2

4AJM

Code 61 Flange - Male Seal-Lok

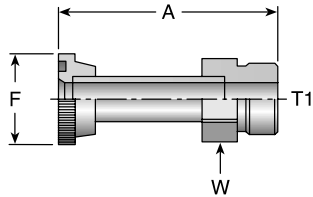

# Part Number	Flange		Thread		A		W	F
	inch		T1		inch	mm	inch	inch
4AJM-12-12	3/4	3/4	1-3/16x12		3.65	93	1-1/4	1-1/2
4AJM-16-16	1	1	1-7/16x12		3.90	99	1-1/2	1-3/4
4AJM-20-20	1-1/4	1-1/4	1-11/16x12		3.92	100	1-3/4	2

4FJM

Code 61 Flange - Male Seal-Lok - 45° Elbow

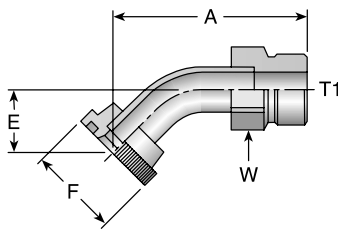

# Part Number	Flange		Thread		A		E		W	F
	inch		T1		inch	mm	inch	mm	inch	inch
4FJM-12-12	3/4	3/4	1-3/16x12		3.22	82	1.06	27	1-1/4	1-1/2
4FJM-16-16	1	1	1-7/16x12		3.64	92	1.27	33	1-1/2	1-3/4
4FJM-20-20	1-1/4	1-1/4	1-11/16x12		3.99	101	1.36	35	1-3/4	2

4NJM

Code 61 Flange - Male Seal-Lok - 90° Elbow

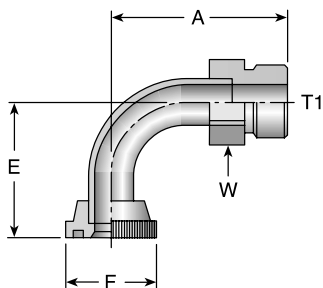

# Part Number	Flange		Thread		A		E		W	F
	inch		T1		inch	mm	inch	mm	inch	inch
4NJM-12-12	3/4	3/4	1-3/16x12		2.90	74	2.24	57	1-1/4	1-1/2
4NJM-16-16	1	1	1-7/16x12		3.38	86	2.81	71	1-1/2	1-3/4
4NJM-20-20	1-1/4	1-1/4	1-11/16x12		4.44	113	2.99	76	1-3/4	2

6AJM

Code 62 Flange - Male Seal-Lok

# Part Number	Flange inch	Thread T1	A		W inch	F inch
			inch	mm		
6AJM-12-12	3/4	1-3/16x12	3.65	93	1-1/4	1-5/8
6AJM-16-16	1	1-7/16x12	3.90	99	1-1/2	1-7/8
6AJM-20-20	1-1/4	1-11/16x12	3.92	100	1-3/4	2-1/8

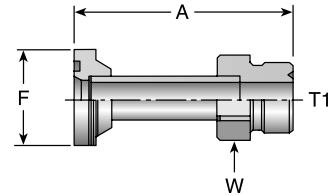

6FJM

Code 62 Flange - Male Seal-Lok - 45° Elbow

# Part Number	Flange inch	Thread T1	A		E		W inch	F inch
			inch	mm	inch	mm		
6FJM-12-12	3/4	1-3/16x12	3.22	82	1.06	27	1-1/4	1-5/8
6FJM-16-16	1	1-7/16x12	3.64	92	1.27	33	1-1/2	1-7/8
6FJM-20-20	1-1/4	1-11/16x12	3.99	101	1.36	35	1-3/4	2-1/8

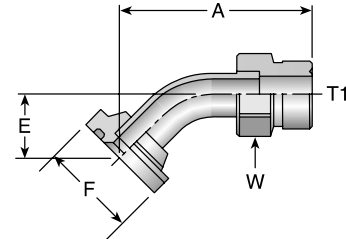

6NJM

Code 62 Flange - Male Seal-Lok - 90° Elbow

# Part Number	Flange inch	Thread T1	A		E		W inch	F inch
			in	mm	in	mm		
6NJM-12-12	3/4	1-3/16x12	2.90	74	2.24	57	1-1/4	1-5/8
6NJM-16-16	1	1-7/16x12	3.38	86	2.81	71	1-1/2	1-7/8
6NJM-20-20	1-1/4	1-11/16x12	4.44	113	2.99	76	1-3/4	2-1/8

6NJM does not include O-rings. Order sperately.

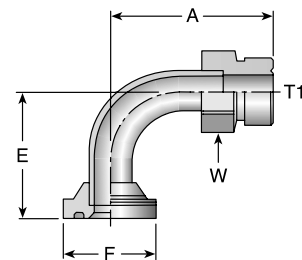

SAE J518 port dimensions for 4-Bolt Split Flanges

There are two non-interchangeable SAE split flanges:

- a. Standard or Code 61 is for 3,000psi to 5,000psi maximum, depending on size.
- b. High Pressure or Code 62 is for 6,000psi maximum, regardless of size. The flange head is "V" notched for identification.

Consult these tables to determine flange halves and flange kits specifications.

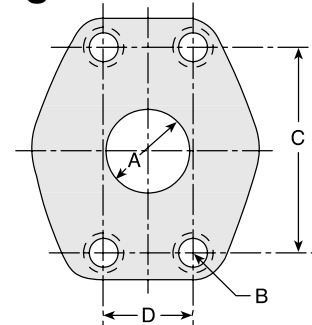

Standard Pressure (Code 61)

Nominal Flange	Flange Dash Size	A Dia Max		B Thread	C		D		Maximum Working Pressure	
		inch	mm		±0.010 inch	±0.25 mm	±0.010 inch	±0.25 mm	psi	MPa
1/2	-8	0.50	13	5/16x18	1.50	38,10	0.68	17,47	5,000	34,5
3/4	-12	0.75	19	3/8x16	1.88	47,63	0.87	22,22	5,000	34,5
1	-16	1.00	25	3/8x16	2.06	52,37	1.03	26,18	5,000	34,5
1 1/4	-20	1.25	32	7/16x14	2.31	58,72	1.18	30,17	4,000*	27,6
1 1/2	-24	1.50	38	1/2x13	2.75	69,85	1.40	35,71	3,000*	20,7
2	-32	2.00	51	1/2x13	3.06	77,77	1.68	42,87	3,000*	20,7

Note: *5000 psi with 4A, 4F and 4N Fittings and 50H Flange Halves.

High Pressure (Code 62)

Nominal Flange	Flange Dash Size	A Dia Max		B Thread	C		D		Maximum Working Pressure	
		inch	mm		±0.010 inch	±0.25 mm	±0.010 inch	±0.25 mm	psi	MPa
3/4	-12	0.75	19	3/8x16	2.00	47,75	0.88	22,35	6,000	41,4
1	-16	1.00	25	7/16x14	2.25	57,15	1.09	27,76	6,000	41,4
1-1/4	-20	1.25	32	1/2x13	2.63	66,67	1.25	31,75	6,000	41,4
1-1/2	-24	1.50	38	5/8x11	3.13	79,37	1.43	36,49	6,000	41,4
2	-32	2.00	51	3/4x10	3.81	96,82	1.75	44,45	6,000	41,4

50H

5000 psi Flange Half (Code 61)

# Part Number	SAE Flange Size	A	B	C	Maximum Working Pressure
	inch	inch	inch	inch	psi
50H-20	1-1/4	2.31	0.55	0.47	5,000
50H-24	1-1/2	2.75	0.66	0.53	5,000
50H-32	2	3.06	0.80	0.53	5,000

Note: For use with 4A, 4F and 4N Flanges.

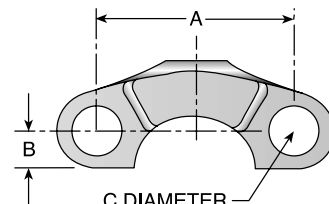

5050HK
5000 psi Flange Kit (Code 61)

# Part Number	SAE Flange Size inch	Maximum Working Pressure (psi)	(2) Flange Halves	O-Ring	(4) Bolts Grade 8		(4) Washers
					Thread inch	Length inch	
5050HK-20	1-1/4	5,000	50H-20	711510-3	7/16x14	1-1/2	7/16
5050HK-24	1-1/2	5,000	50H-24	711510-2	1/2x13	1-1/2	1/2
5050HK-32	2	5,000	50H-32	711510-1	1/2x13	1-1/2	1/2

Note: For use with 4A, 4F and 4N Flanges.

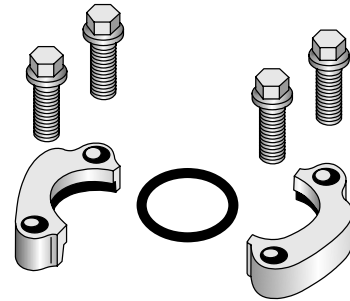

51H
SAE Flange Half (Code 61)

# Part Number	SAE Flange Size inch	A inch	B inch	C inch	Maximum Working Pressure psi
51H-8	1/2	1.50	0.31	0.34	5,000
51H-12	3/4	1.88	0.40	0.41	5,000
51H-16	1	2.06	0.48	0.41	5,000
51H-20	1-1/4	2.31	0.56	0.47	4,000
51H-24	1-1/2	2.75	0.67	0.53	3,000
51H-32	2	3.06	0.81	0.53	3,000
51H-40	2-1/2	3.50	0.96	0.53	2,500
51H-48	3	4.19	1.18	0.66	2,000

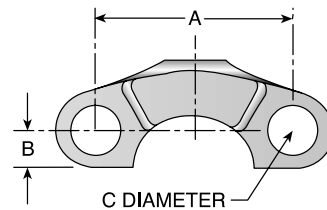

5151HK
SAE Flange Kit (Code 61)

# Part Number	SAE Flange Size inch	Maximum Working Pressure (psi)	(2) Flange Halves	O-Ring	(4) Bolts Grade 8		(4) Washers
					Thread inch	Length inch	
5151HK-8	1/2	5,000	51H-8	711510-6	5/16x18	1-1/4	5/16
5151HK-12	3/4	5,000	51H-12	711510-5	3/8x16	1-1/4	3/8
5151HK-16	1	5,000	51H-16	711510-4	3/8x16	1-1/4	3/8
5151HK-20	1-1/4	4,000	51H-20	711510-3	7/16x14	1-1/2	7/16
5151HK-24	1-1/2	3,000	51H-24	711510-2	1/2x13	1-1/2	1/2
5151HK-32	2	3,000	51H-32	711510-1	1/2x13	1-1/2	1/2
5151HK-40	2-1/2	2,500	51H-40	711510-7	1/2x13	1-3/4	1/2
5151HK-48	3	2,000	51H-48	711510-8	5/8-11	1-3/4	5/8

Note: High pressure applications also require the use of Code 61 Flange End hose fittings.

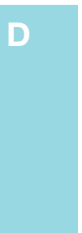
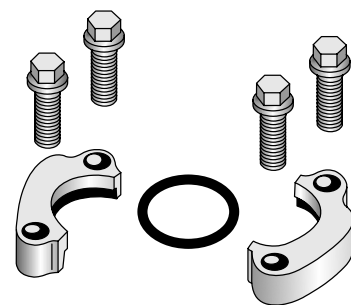

HFH
SAE Flange Half (Code 62)

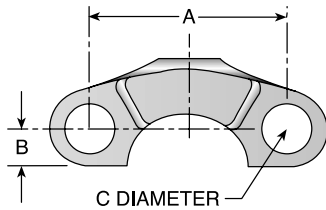

# Part Number	SAE Flange Size inch	A inch	B inch	C inch	Maximum Working Pressure psi
HFH-12	3/4	2.00	0.43	0.41	6,000
HFH-16	1	2.25	0.51	0.47	6,000
HFH-20	1 1/4	2.62	0.59	0.53	6,000
HFH-24	1 1/2	3.12	0.68	0.66	6,000
HFH-32	2	3.81	0.84	0.78	6,000

HFHFHK
SAE Flange Kit (Code 62)

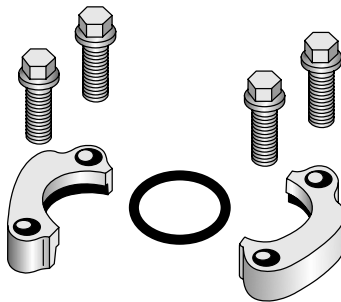

# Part Number	SAE Flange Size inch	Maximum Working Pressure psi	(2) Flange Halves	O-Ring	(4) Bolts Grade 8		(4) Washers
					Thread inch	Length inch	
HFHFHK-12	3/4	6,000	HFH-12	711510-5	3/8x16	1-1/2	3/8
HFHFHK-16	1	6,000	HFH-16	711510-4	7/16x14	1-3/4	7/16
HFHFHK-20	1-1/4	6,000	HFH-20	711510-3	1/2x13	1-3/4	1/2
HFHFHK-24	1-1/2	6,000	HFH-24	711510-2	5/8x11	2-1/4	5/8
HFHFHK-32	2	6,000	HFH-32	711510-1	3/4x10	2-3/4	3/4

8FH
Flange Half (8000 psi)

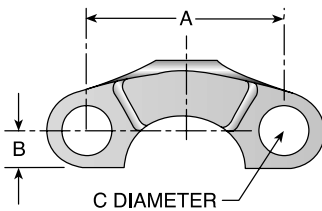

# Part Number	SAE Flange Size inch	A inch	B inch	C inch	Maximum Working Pressure psi
8FH-12	3/4	2.00	0.43	0.41	8,000
8FH-16	1	2.25	0.51	0.47	8,000

8HFHFHK
Flange Kit (8000 psi)

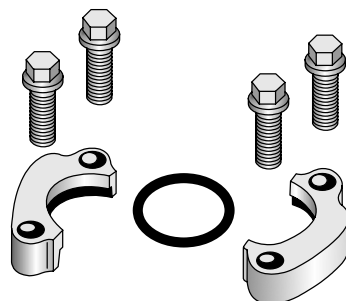

# Part Number	SAE Flange Size inch	Maximum Working Pressure psi	(2) Flange Halves	D-Ring	(4) Bolts Grade 8		(4) Washers
					Thread inch	Length inch	
8HFHFHK-12	3/4	8,000	8FH-12	8ARG-12	3/8-16	1-3/4	3/8
8HFHFHK-16	1	8,000	8FH-16	8ARG-16	7/16-14	1-3/4	7/16

Full Flange System

SAE J1518 Code 61 or Code 62

Parker's Hose Products Division introduces a one-piece flange option for Code 61 and Code 62 connections. The patent-pending design enables the flange to be attached to the hose after the hose fitting has been crimped to the hose. Once the fitting is crimped, an SAE J1518 Code 61 or a Code 62 full flange can be attached using the high tensile stainless steel retaining ring. The versatile fitting design enables greater flexibility by reducing the number of potential hose fittings in your inventory.



Product Features

- One-piece full flange connection
- The full flange system is designed to work with all Parkrimp crimpers
- Fittings are compatible for both Code 61 and Code 62 flanges
- All Code 61 sizes rated to 5000 psi

Flange Kits:

Code 61 Flange Kit - All sizes rated for 5000 psi

Part Number	SAE Flange Size inch	Maximum Working Pressure psi	Flange	Seal	Retaining Ring	(4) Bolts Grade 8	
						Thread inch	Length inch
FFK61-12	3/4	5,000	R312-35-CFX	XRG-12	R12X	UNC 3/8 - 16	1-1/2
FFK61-16	1	5,000	R316-CFX	XRG-16	R16X	UNC 3/8 - 16	1-1/2
FFK61-20	1 1/4	5,000	R320-12.5-CFX	XRG-20	R20X	UNC 7/16 - 14	1-1/2
FFK61-24	1 1/2	5,000	R324-CFX	XRG-24	R24X	UNC 1/2 - 13	1-3/4
FFK61-32	2	5,000	R332-CFX	XRG-32	R32X	UNC 1/2 - 13	1-3/4

Code 62 Flange Kit

Part Number	SAE Flange Size inch	Maximum Working Pressure psi	Flange	Seal	Retaining Ring	(4) Bolts Grade 8	
						Thread inch	Length inch
FFK62-12	3/4	6,000	R612-35-CFX	XRG-12	R12X	UNC 3/8 - 16	1-1/2
FFK62-16	1	6,000	R616-CFX	XRG-16	R16X	UNC 7/16 - 14	1-1/2
FFK62-20	1 1/4	6,000	R620-CFX	XRG-20	R20X	UNC 1/2 - 13	1-3/4
FFK62-24	1 1/2	6,000	R624-CFX	XRG-24	R24X	UNC 5/8 - 11	2-1/4
FFK62-32	2	6,000	R632-CFX	XRG-32	R32X	UNC 3/4 - 10	2-3/4

Kit Part Number	Retaining Ring	O-ring
RK-12	R12X	XRG-12
RK-16	R16X	XRG-16
RK-20	R20X	XRG-20
RK-24	R24X	XRG-24
RK-32	R32X	XRG-32

The stainless steel retaining rings and O-rings are recommended for one-time use. Order additional ring kits using the part numbers shown.



DIN and ISO Metric Ports

DIN (German) and ISO (International Organization for Standardization) flange heads are the same as SAE flange heads. By comparison, the ports have the same configuration except that the DIN and ISO Type I ports accept metric bolts. This requires special flange halves in most sizes.

SAE J518	DIN 20078	ISO 6162 Type I
Code 61	Form R	3,5 to 35 MPa Series
Code 62	Form S	35 to 40 MPa Series

M1H DIN (ISO) Flange Half

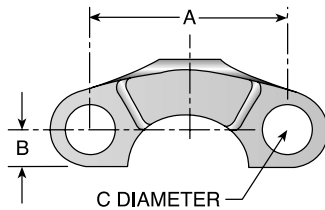

# Part Number	DIN Flange Size	ISO Flange Size	A mm	B mm	C mm	Maximum Working Pressure	
						psi	MPa
M1H-8	8	13	38	8	9	5,000	34,5
M1H-12	12	19	48	10	11	5,000	34,5
M1H-16	16	25	52	12	11	5,000	34,5
M1H-20	20	32	59	14	11	4,000	27,6
M1H-24	24	38	70	17	13.5	3,000	20,7
M1H-32	32	51	78	21	13.5	3,000	20,7
M1H-40	40	64	89	24	13.5	2,500	17,2

Note: High pressure applications also require the use of Code 62 Flange End hose fittings.

M1M1HK DIN (ISO) Flange Kit (Code 61)

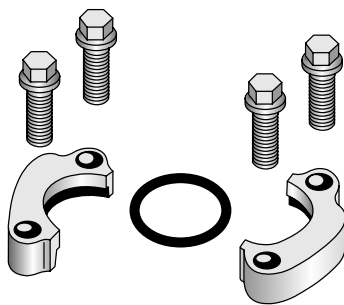

# Part Number	DIN Flange Size	ISO Flange Size	Maximum Working Pressure		(2) Flange Halves	O-Ring	(4) Bolts		(4) Washers
			psi	MPa			Thread mm	Length mm	
M1M1HK-8	8	13	5,000	34,5	M1H-8	711510-6	M8x1.25	30	10
M1M1HK-12	12	19	5,000	34,5	M1H-12	711510-5	M10x1.50	30	10
M1M1HK-16	16	25	5,000	34,5	M1H-16	711510-4	M10x1.50	30	10
M1M1HK-20	20	32	4,000	27,6	M1H-20	711510-3	M10x1.50	40	10
M1M1HK-24	24	38	3,000	20,7	M1H-24	711510-2	M12x1.75	40	12
M1M1HK-32	32	51	3,000	20,7	M1H-32	711510-1	M12x1.75	40	12
M1M1HK-40	40	64	2,500	17,2	M1H-40	711510-7	M12x1.75	45	12

M2H

DIN (ISO) Flange Half (Code 62)

# Part Number	DIN Flange Size	ISO Flange Size	A mm	B mm	C mm	Maximum Working Pressure	
						psi	MPa
M2H-8	8	13	41	8	9	6,000	41,5
M2H-12	12	19	51	11	11	6,000	41,5
M2H-16	16	25	57	13	13,5	6,000	41,5
M2H-20	20	32	67	15	15	6,000	41,5
M2H-24	24	38	79	17	17,5	6,000	41,5
M2H-32	32	51	97	21	22	6,000	41,5

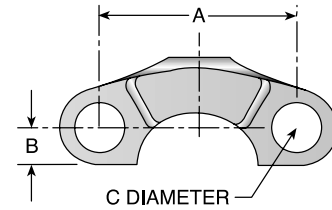

A

M2M2HK

DIN (ISO) Flange Kit (Code 62)

# Part Number	DIN Flange Size	ISO Flange Size	Maximum Working Pressure		(2) Flange Halves	O-Ring	(4) HHCS		(4) Washers
			psi	MPa			Thread mm	Length mm	
M2M2HK-8	8	13	6,000	41,5	M2H-8	711510-6	M8x1.25	30	8
M2M2HK-12	12	19	6,000	41,5	M2H-12	711510-5	M10x1.50	35	10
M2M2HK-16	16	25	6,000	41,5	M2H-16	711510-4	M12x1.75	45	12
M2M2HK-20	20	32	6,000	41,5	M2H-20	711510-3	M14x2.00	45	12
M2M2HK-24	24	38	6,000	41,5	M2H-24	711510-2	M16x2.00	55	16
M2M2HK-32	32	51	6,000	41,5	M2H-32	711510-1	M20x2.50	70	20

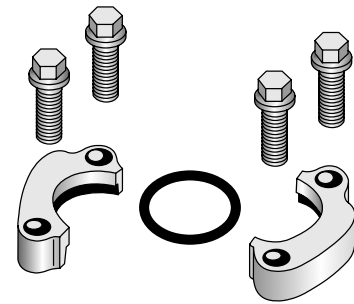

B

C

XCXCHK

Caterpillar® Flange Kits

# Part Number	C Diameter inch	Maximum Working Pressure psi	O-Ring	(4) Bolts Grade 8		(4) Washers
				Thread mm	Length mm	
XCXCHK-12	0.406	6,000	8ARG-12	3/8-16	1.75	3/8
XCXCHK-16	0.469	6,000	8ARG-16	7/16-14	1.75	7/16
XCXCHK-20	0.531	6,000	8ARG-20	1/2-13	2.00	1/2
XCXCHK-24	0.656	6,000	8ARG-24	5/8-11	2.50	5/8
XCXCHK-32	0.827	6,000	8ARG-32	3/4-10	2.75	3/4

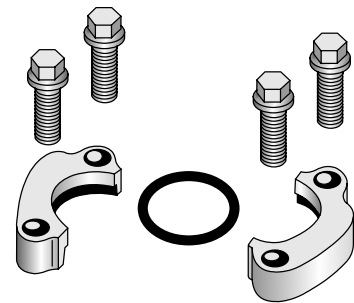

D

E

711509

O-Rings - SAE Thread (Compound N552-90)*

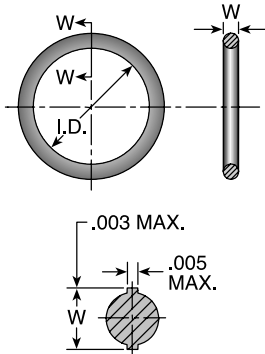

# Part Number	Tube Dash Size	Tube O.D. inch	SAE Thread inch	W		I.D.	
				inch	mm	inch	mm
711509-1	-4	1/4	7/16x20	0.072	1,83	0.351	8,92
711509-2	-5	5/16	1/2x20	0.072	1,83	0.414	10,52
711509-3	-6	3/8	9/16x20	0.078	1,98	0.468	11,89
711509-4	-8	1/2	3/4x16	0.087	2,21	0.644	16,36
711509-5	-10	5/8	7/8x14	0.097	2,46	0.755	19,18
711509-6	-12	3/4	1-1/16x12	0.116	2,95	0.924	74,93
711509-7	-16	1	1-5/16x12	0.116	2,95	1.171	29,74
711509-8	-20	1-1/4	1-5/8x12	0.118	3,00	1.475	37,47
711509-9	-24	1-1/2	1-7/8x12	0.118	3,00	1.720	43,69
711509-10	-32	2	2-1/2x12	0.118	3,00	2.337	59,36

711510

O-Rings - Code 61 and Code 62 Flanges (Compound N552-90)*

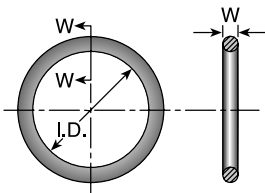

# Part Number	Flange Dash Size	Flange Size inch	W		I.D.	
			inch	mm	inch	mm
711510-6	-8	1/2	0.14	3,53	0.73	18,64
711510-9*	-10	5/8	0.14	3,53	0.79	20,20
711510-5	-12	3/4	0.14	3,53	0.98	25,00
711510-4	-16	1	0.14	3,53	1.29	32,92
711510-3	-20	1-1/4	0.14	3,53	1.48	37,69
711510-2	-24	1-1/2	0.14	3,53	1.85	47,22
711510-1	-32	2	0.14	3,53	2.23	56,74
711510-7	-40	2-1/2	0.14	3,53	2.73	69,44
711510-8	-48	3	0.14	3,53	3.35	85,32

*Note: For use with petroleum base fluids, other compounds available for Phosphate Ester fluids. Please contact The Parker Hannifin Seal Group/O-Ring Division (1-800-C-PARKER) for additional information.

C9RG

O-Rings for CA, CE, CF Metric

# Part Number	W mm	I.D. mm
C9RG-8	1,5	6,0
C9RG-10	1,5	7,5
C9RG-12	1,5	9,0
CARG-15	2,0	12,0
CARG-18	2,0	15,0
CARG-22	2,0	20,0
CARG-28	2,0	26,0

C9RG

O-Rings for C9, OC, 1C Metric Swivels

# Part Number	W mm	I.D. mm
C9RG-8	1,5	6,0
C9RG-10	1,5	7,5
C9RG-12	1,5	9,0
C9RG-14	2,0	10,0
C9RG-20	2,4	16,3
C9RG-25	2,4	20,3
C9RG-30	2,4	25,3
C9RG-38	2,5	33,0

D9DT

Bonded Seal for BSPP Port Fittings

# Part Number	I.D.		O.D.	
	Inch	mm	Inch	mm
D9DT-4	0.54	13,7	0.81	20,6
D9DT-6	0.68	17,3	0.94	23,9
D9DT-8	0.85	21,6	1.13	28,7
D9DT-10	0.93	23,6	1.25	31,8
D9DT-12	1.06	27,0	1.38	35,1
D9DT-16	1.33	33,8	1.68	42,7

*Note: D9DT must be ordered from the Tube Fittings Division. Please contact TFD for additional size and product information.

JORG
O-Rings - Seal-Lok®

Part Number	Tube Dash Size	Tube O.D. Inch	SAE Thread Inch	I.D.		O.D.	
				Inch	mm	Inch	mm
JORG-4	-4	1/4	9/16x18	0.301	7,65	0.070	1,78
JORG-6	-6	3/8	11/16x16	0.364	9,25	0.070	1,78
JORG-8	-8	1/2	13/16x16	0.489	12,42	0.070	1,78
JORG-10	-10	5/8	1x14	0.614	15,59	0.070	1,78
JORG-12	-12	3/4	1-3/16x12	0.739	18,77	0.070	1,78
JORG-16	-16	1	1-7/16x12	0.926	23,52	0.070	1,78
JORG-20	-20	1-1/4	1-11/16x12	1.176	29,87	0.070	1,78
JORG-24	-24	1-1/2	2x12	1.489	37,82	0.070	1,78

Note: O-Rings for use in Seal-Lok® connections are illustrated in actual size. Part numbers for O-Rings used in Seal-Lok® and in SAE port connections are also listed in the table. O-Rings are supplied in Nitrile NBR compound, 90 durometer hardness.

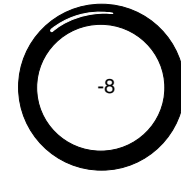

SAE 711509-4



Seal-Lok JORG-8

Photo shows an actual comparison between an SAE port O-Ring (top) and a Seal-Lok® O-Ring (bottom). They differ in both diameter and cross section.

XARG
Flange "D" Rings Caterpillar® Style Flanges

Part Number	Flange Size	Dash Size	I.D.		O.D.	
			Inch	mm	Inch	mm
XARG-12	3/4	-12	0.20	5,0	1.00	25,4
XARG-16	1	-16	0.20	5,0	1.25	31,8
XARG-20	1-1/4	-20	0.20	5,0	1.50	38,1
XARG-24	1-1/2	-24	0.20	5,0	1.75	44,5
XARG-32	2	-32	0.20	5,0	2.52	63,9

8ARG
Flange "D" Rings for 76 Series Style Flange

Part Number	Flange Size	Dash Size	Seal Thickness		Seal I.D.	
			Inch	mm	Inch	mm
8ARG-12	3/4	-12	0.20	5,0	1.00	25,4
8ARG-16	1	-16	0.20	5,0	1.25	31,9

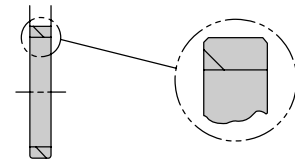

A

B

C

D

E

59RG

O-Rings for Tube O-Ring Fittings and Compressor Fittings

Part Number	Tube O.D. Inch	Tube Dash Size	Parker Seal Number
59RG-6	3/8	-6	2-011
59RG-8	1/2	-8	2-013
59RG-10	5/8	-10	2-015
59RG-12	3/4	-12	2-017

Note: The above O-Rings (RG) have HNBR compound number N1195-70 (green).

T1RG

O-Rings for Compression Fittings (1T126)

Part Number	Tube O.D. Inch	Tube Dash Size	Parker Seal Number
T1RG-6	3/8	-6	2-012
T1RG-8	1/2	-8	2-014
T1RG-10	5/8	-10	2-016
T1RG-12	3/4	-12	2-018

Charge Ports Caps R134a

Part Number	Fitting Size	Fitting Shape	Port Type	
			Flow	Side
940199	-6 & -8	Straight	High	High
940200	-10 & -12	Straight	High	Low
940188	-6 & -8	Elbows	Standard	High
940189	-10 & -12	Elbows	Standard	Low

R12

Part Number	Thread
940249	7/16x20

CORG

Captive O-Ring Assembly Tools

Parker's new CORG Assembly Tools are designed to facilitate the installation of the O-Ring into the half-dovetail groove of the O-Ring face seal fitting.

Fitting Size	Hand Type Part Number	Bench Type Part Number
-4	CORG-4	CORG-AT04 Bench
-6	CORG-6	CORG-AT06 Bench
-8	CORG-8	CORG-AT08 Bench
-10	CORG-10	CORG-AT10 Bench
-12	CORG-12	CORG-AT12 Bench
-16	CORG-16	CORG-AT16 Bench
-20	CORG-20	CORG-AT20 Bench
-24	CORG-24	CORG-AT24 Bench
-32	CORG-32	



Bench Type



Hand Type

Note: CORG Assembly Tools must be ordered from the Tube Fittings Division (614) 279-7070.

Note: O-Rings listed are for use with petroleum base fluids. Other compounds are available for Phosphate Ester fluids by special order. For Viton® or other O-Ring compounds, consult Parker Hannifin, Seal/O-Rings Products Division (1-800-C-PARKER.)

Partek Defense

Reliable, Long-Lasting Protection

Partek Defense is the newest addition to the Partek line of hose sleeving products. Partek Defense is designed to provide protection to personnel and equipment in the event of a hose burst by containing the energy of the burst.

Partek Defense features a multi-layered construction that contains and then dissipates the energy and media within the hose assembly.

Partek Defense can be applied in any hose application but is most valuable in industries such as mining, construction and agriculture where operators are in close proximity to high-pressure hose.



Product Features

- Contains hose bursts up to 12,000 psi
- MSHA rated
- Meets ISO 3457, ISO 4413, EN414,MDG41
- Made of high-performance materials and a proprietary weave pattern for reliable, long-lasting protection
- Easy to assemble
- Packaged in 50-ft. reels for easy storage and access.
- Flexible, does not restrict hose routings
- Specially coated fibers protect against deterioration due to sunlight, ozone and other environmental elements
- Secured to hose shell using hose band and clamps

Partek Defense Hose Sleeve

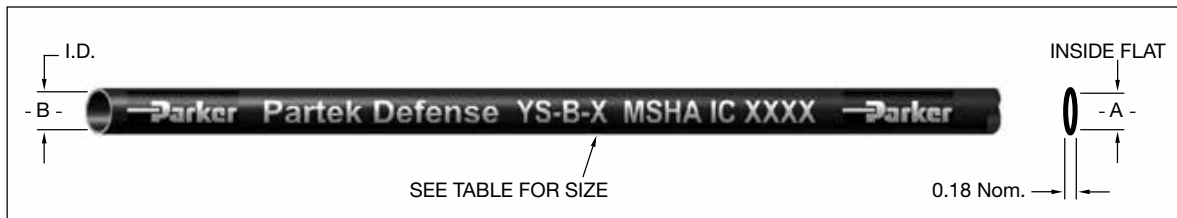

Part Number	Hose Size ID*	Sleeve Flat ID "A"		Sleeve Round ID "B"	
		inch	mm	inch	mm
YS-B-17	-4	1.92	49	1.22	31
YS-B-19	-6	2.12	54	1.35	34
YS-B-22	-8	2.24	57	1.45	36
YS-B-27	-10	2.55	65	1.63	41
YS-B-33	-12	2.85	72	1.81	46

*Approved with 43, 70, 71, 73, 77, 78 and 79 Series fittings.



Partek Wrap

The need for a protective hose sleeve is not always considered while designing for a hose's application. Many hose assembly installations would benefit from a sleeve, but it is not obvious until all the other hoses and components are in place. Parker's Partek Wrap enables the hose sleeve to be installed after the hose assemblies have been positioned and secured in place. The Partek Wrap can be used as extra abrasion protection or to wrap multiple hoses or cables together.

Product Features

- Post assembly installation
- Light weight and highly flexible
- Urethane-coated 1050 Ballistic Nylon
- Ambient temperature range of -60°F to +200°F
- Fast and easy installation
- MSHA Certified for use in underground mines



Partek Wrap

Part Number	Bundle O.D.	Circumference inch	Open Width (+/- 0.375) inch	Roll Length feet	Color
PS-BV-300	3	9.40	10.90	50	Black
PS-BV-400	4	12.50	14.00	50	Black
PS-BV-500	5	15.75	17.25	50	Black
PS-BV-700	7	22.00	23.50	50	Black

Other sizes available upon request with minimum order.



Accessory Selection Guide – Partek Sleeve (AS-B, AS-Y or PS)

Parker's Partek Nylon Protective Sleeve gives you tough hose abrasion protection two ways. First, per the ISO 6945 specification, Partek has a unique tubular weave nylon construction, Partek "AS" is strong enough to withstand greater than 200,000 abrasion cycles without wearing through the fabric at any location. Partek "PS" can withstand greater than 50,000 abrasion cycles. In addition, this weave also gives an exceptionally smooth interior wall, allowing rubber hose to move freely inside the sleeve. This provides easy installation and prevents any internal abrasion problems. Partek sleeving is available in either black or yellow and in sizes to fit most hydraulic hose. Partek, the quick and easy solution to hose protection in high-abrasion areas.

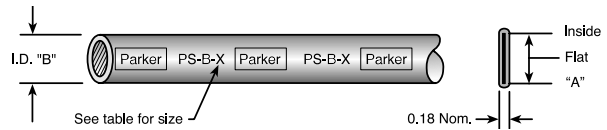

Note: The inside flat "A" dimension corresponds with the inside diameter "B" dimension. For example, AS-Y-13 flat surface "A" is 1.34 in. This offers a .86 in. inside diameter "B". Hose with a smaller O.D. can be specified for this size sleeve. Parker 201-5 hose has a .58 in. O.D. and can easily be inserted in the Partek AS-Y-13 Sleeve.

Temperature Range: -67°F to +248°F (-53°C to +120°C)

- MSHA Certified for use in underground mines



Partek Sleeve



Partek "PS" Sleeve

Partek Sleeve Application - Hose Type/Size

Partek Sleeve Black Part Number	Partek Sleeve Yellow Part Number	Partek PS Sleeve Black Part Number	Inside Diameter		SS25UL 201, 206 221FR 225, 235 244 266	213 271 285 293	BXX 302 301LT 304 381 421WC	AX, MX 351TC, 351ST 422, 424 426, 431 436, 451TC 451ST, 471TC 471ST, 472LT, 472TC 482TC, 482ST	273	601 604 636 646	701, 711 721, 721TC 721ST, 722LT 722LT, 722TC 772TC, 774 787TC, 797TC	731, 781 782TC 791TC 792LT 792TC 792ST F42, P35	801 804 821 831 836	811 811HT 881	275	761	Twin Line
			A	B													
AS-B-11	AS-Y-11		1.07	0.69	-4	-4		-3,-4									
AS-B-13	AS-Y-13	PS-B-13	1.34	0.86	-5,-6	-5,-6	-4,-5	-5,-6	-4	-4,-5					-5,-6		
AS-B-15	AS-Y-15	PS-B-15	1.66	1.06	-8	-8,-10	-6	-8	-6	-6	-6				-8		
AS-B-17	AS-Y-17	PS-B-17	1.92	1.22	-10	-12	-8,-10	-10	-8	-8	-8				-10		
AS-B-19	AS-Y-19		2.12	1.35	-12			-12	-10	-10	-10	-8			-12	-12	-10
AS-B-22	AS-Y-22	PS-B-22	2.24	1.42	-16	-16	-12		-12	-12	-12	-10			-16	-16	
AS-B-27	AS-Y-27		2.55	1.63				-16			-12						-12
AS-B-33	AS-Y-33	PS-B-33	2.85	1.81	-20	-20	-16		-16	-16	-16				-16		-12
		PS-B-35	3.43	2.19	-24	-24		-20							-20	-20	-20
AS-B-37	AS-Y-37	PS-B-37	3.73	2.38			-20	-24			-20	-20					
		PS-B-39	4.12	2.63	-32	-32	-24				-24	-24			-24		
		PS-B-45	4.53	2.88			-32					-32					
AS-B-58		PS-B-47	4.90	3.13	-40	-40					-32						
AS-B-64			5.69	3.63	-48	-48								-48			
			6.18	4.00													

- Note:**
1. The dimensions shown are related to the hose outside diameter and may not fit over the fitting. For over the fitting applications, a larger size sleeve may be required.
 2. Cut lengths are available. Contact your local distributor for prices (www.parkerhose.com).



Accessory Selection Guide – PolyGuard (HG)

- Shield hose from abrasion and cuts
- Minimize kinking
- Cannot rust or corrode

Heavy-duty polyethylene provides protection in rugged operating conditions. Great for bundling high-pressure hose lines.

Cut edges can be smoothed by applying heat.

CAUTION: This material will support combustion.

Color: Black

Temperature Range: 0°F to +200°F (-17°C to +93°C)

Lower-cost protection for applications that call for a tighter bend radius and are less demanding.

Cut edges can be smoothed by applying heat.

CAUTION: This material will support combustion.

Color: Black

Temperature Range: 0°F to +200°F (-17°C to +93°C)

- Resist water, oil, gasoline, hydraulic fluid, and most solvents
- Ideal for bundling plastic tubing or hose lines
- Easy to install without removing hose lines; no clamps needed



PolyGuard



ParKoil™

PolyGuard (HG), ParKoil (PG) Application - Hose Type/Size

Poly Guard Part Number	ParKoil Part Number	Inside Dia.	SS25UL 201, 206 221FR 225, 235 244 266 285 293	213 271 304	BXX 302 301LT 381 421WC	AX, MX 351TC, 351ST 422, 424 426, 431 436, 451TC 451ST, 471TC 472TC 482TC, 482ST	273	601 604 636 646	701, 711 721, 721TC 721ST, 722LT 722TC 772TC 772ST, 774 787TC, 797TC	731, 781 782TC 782ST 791TC 792LT 792TC 792ST	F42, P35	801 804 821 831 811HT 881	275	761	Twin Line
HG-075		0.75	-8,-10	-8,-10	-6,-8	-8,-10	-6,-8	-6,-8	-4,-6			-8,-10	-10		
HG-100		1.00	-12	-12	-10,-12	-12	-10	-10	-8,-10			-12	-12	-10	
HG-125		1.25	-16	-16		-16		-12	-12	-12		-16	-16	-12	
HG-150		1.50	-20,-24	-20,-24	-16,-20	-20		-16,-20	-16	-16,-20		-16,-20	-20	-16	
HG-200		2.00	-32,-40	-32,-40	-24,-32	-24,-32			-20,-24,-32	-24,-32		-24,-32,-40	-24	-20	
HG-350		3.50	-48	-48								-48			
	PG-038	0.38		-4		-3									
	PG-050	0.50	-4,-5	-5	-3,-4	-4,-5	-4	-4				-4			
	PG-062	0.62	-6	-6,-8	-5	-6						-6			
	PG-075	0.75	-8	-10	-6	-8	-6	-6	-6			-8			
	PG-088	0.88	-10	-12	-8	-10	-8	-8	-8			-10			
	PG-100	1.00	-12		-10,-12	-12	-10	-10	-10	-10		-12	-10	-10	
	PG-138	1.19	-16	-16				-12	-12	-12		-16	-12		
	PG-138	1.38	-20,-24	-20,-24	-16	-16,-20	-16	-16	-16,-20	-16		-16,-20	-16,-20	-12,-16	6-6,6-8
	PG-188	1.88	-32,-40,-48	-32,-40,-48	-20,-24,-32	-24,-32			-24,-32	-20,-24,-32		-24,-32	-24	-20	8-8

Accessory Selection Guide – Spring Guard and Armor Guard

Parker Spring Guard and Armor Guard are two products that prolong the life of hose lines that are exposed to rugged operating conditions. They distribute bending radii to avoid kinking in hose lines and protect hose from abrasion and deep cuts. Guards are constructed of steel wire and plated to resist rust.



Spring Guard (SG)



Armor Guard (AG)

Spring Guard/Armor Guard Application - Hose Type/Size

Spring Guard Part Number	Armor Guard Part Number	Inside Dia.	SS25UL 201, 206 221FR 225, 235 244 266	213 271 285 293	BXX 302 301LT 304 421WC	AX, MX 351TC, 351ST 422, 424 426, 431 436, 451TC 451ST, 471TC 471ST, 472LT, 472TC 482TC, 482ST	273	601 604 636 646	701, 711 721, 721TC 721ST, 722LT 722TC 772TC, 772ST 774 787TC, 797TC	731, 781 782TC 782ST 791TC 792LT 792TC 792ST F42, P35	801 804 821 821FR 831 836	811 811HT 881	275	761	Twin Line
SG-050	AG-050	0.50		-4		-3									
SG-060	AG-060	0.60	-4	-5	-3	-4		-3,-4			-4,-5				
SG-066	AG-066	0.66	-5	-6	-4	-5	-4								
SG-072	AG-072	0.72	-6		-5	-6		-5			-6				
SG-084	AG-084	0.84	-8	-8	-6	-8	-6	-6	-4,-6	-4	-8				
SG-097	AG-097	0.97	-10	-10	-8	-10	-8	-8	-8	-6	-10			-10	
SG-106	AG-106	1.06		-12	-10		-10			-8					
SG-113	AG-113	1.13	-12			-12		-10	-10		-12				
SG-122	AG-122	1.22			-12					-10				-12	-10
SG-131	AG-131	1.31	-16	-16				-12	-12	-12	-16	-12			
SG-155	AG-155	1.55	-20	-20	-16	-16		-16	-16			-16	-16	-12	6-6,8-8
SG-161		1.61								-16					
SG-166		1.66													
SG-182	AG-182	1.82	-24	-24		-20		-20	-20*			-20	-20	-16	8-8
SG-209	AG-209	2.09			-20	-24			-20	-20			-24		
SG-232	AG-232	2.32	-32		-24					-24				-20	
SG-292	AG-292	2.92										-40			

*SG-182 for size -20 hose is only for 787TC and 797TC.

Note: Spring Guard and Armor Guard are packaged in 10 ft. pieces.

Polyguard Strain Reliever

Temperature Range: -40°F to +225°F

Material: Flexible PVD

Color: Black (check for availability of other colors)

Part Number	Length inches	Hose O.D. inches
4PG	7	0.53
6PG	7	0.63
7PG	7	0.69
8PG	7	0.84



Hose Whip Restraint

Safety restraining system for pressure hoses

Parker's Hose Whip Restraint System is designed to prevent whipping of a pressurized hose in the event of the hose separating from its fitting. The Hose Whip Restraint System provides an additional level of safety and helps prevent damage to nearby equipment or injury to operators near the failed hose by limiting the whip or travel of the pressurized hose after it breaks free from its hose fitting. Serious damage or injury can occur from whipping hoses, especially at higher pressures.

The system is comprised of two parts – a hose collar and a cable assembly. The hose collar (WRCxxxx) is selected based

on the outside diameter of the hose, and the cable assembly is selected based on the type of hose connection. Two types of cable assemblies are available – one for flange-type connections (WRFxxx), and the other for port adapters (WRAxxx).

The Hose Whip Restraint is not to be used in place of proper hose crimping procedures as outlined in HPD Catalog 4400. Exceeding the maximum operating pressure of the hose jeopardizes the proper operation of the Hose Whip Restraint System.



Hose collars for Hose Whip Restraint System

# Part Number	A		B	
	inch	mm	inch	mm
WRC1212	0.47	12,0	0.492	12,5
WRC1313	0.51	13,0	0.531	13,5
WRC1415	0.55	14,0	0.591	15,0
WRC1718	0.67	17,0	0.709	18,0
WRC1819	0.71	18,0	0.748	19,0
WRC2021	0.79	20,0	0.827	21,0
WRC2223	0.87	22,0	0.906	23,0
WRC2425	0.95	24,0	0.984	25,0
WRC2526	0.98	25,0	1.024	26,0
WRC2728	1.06	27,0	1.102	28,0
WRC2829	1.10	28,0	1.142	29,0
WRC3031	1.18	30,0	1.220	31,0
WRC3435	1.34	34,0	1.378	35,0
WRC3637	1.42	36,0	1.457	37,0
WRC3839	1.50	38,0	1.535	39,0
WRC4445	1.73	44,0	1.772	45,0
WRC4547	1.77	45,0	1.850	47,0
WRC4850	1.89	48,0	1.969	50,0
WRC5153	2.01	51,0	2.087	53,0
WRC5456	2.13	54,0	2.205	56,0
WRC6365	2.48	63,0	2.559	65,0
WRC6971	2.72	69,0	2.795	71,0

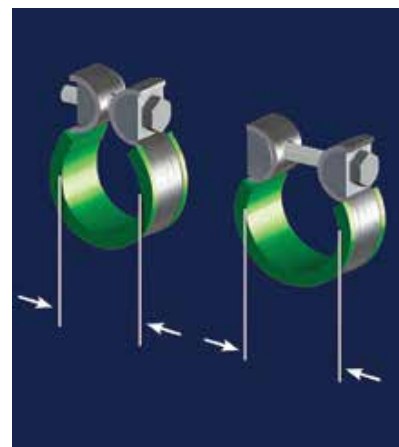

Accessory Selection Guide – Firesleeve (FS-F)

Parker Firesleeve is a flame resistant sheath that protects the hose from extreme temperature conditions. Firesleeve easily slides over hoses and readily expands over fitting. It can be assembled with Parker FSC or properly sized wormgear clamp.

Construction: Braided fiberglass sleeve and an orange, bonded and seamless silicone rubber cover.

Specifications: Conforms to SAE Aerospace Standard 1072A Type 2A.

Temperature Range: -54°C to +260°C (-65°F to +500°F).

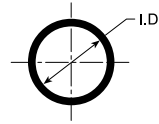

Note: The Firesleeve inside dimension (I.D.) must exceed the outside diameter (O.D.) of the hose and offer an allowance for easy hose insertion. For example, 201-16 has a 1.23 in. O.D. FS-S-24, with an I.D. of 1.46 in., is the suggested Firesleeve.

Note: Parker FSC Clamp fits all hoses up to 2 in. O.D.

Note: Parker HC Clamps (wormgear) are listed on page D-28.



Firesleeve (FS-F)



FSC Clamp

Part Number: FSC
(One size fits all hoses up to 2 inch O.D.)

Proudly offering the following certifications and specifications

- UL 1441 Certified
- VW1 Flame Test Certified
- MSHA Certified for use in underground mines
- SAE AS1072E
- GL - Germanischer Lloyd Certified for 800°C for 30 minutes
- BS EN 373 Molten Splash Tested
- BS EN 388 Abrasion Tested
- BS EN ISO 6940 Flame Resistance Tested
- BS EN ISO 6530 Oil Resistance Tested
- BS 2576 Tensile Strength Tested
- DIN 54837 / 5510-2 Rail Vehicle Certified for Resistance to Combustibility
- DIN 5659-2 / 5510-2 Rail Vehicle Certified for Toxicity
- ASTM C177 Thermal Conductivity

“FS - F” Application - Hose Type/Size

Part Number	Inside Dia.	SS25UL		BXX	AX, MX		601	604	701, 711		731, 781		801	804	811	811HT	275	761	Twin Line
		201, 206	213		301LT	351TC, 351ST			422, 424	426, 431	721, 721TC	782ST							
FS-F-10	0.58	-4	-4	-3	-3,-4	-3	-3						-4						
FS-F-11	0.65	-5	-5	-4	-5	-4	-4												
FS-F-12	0.71		-6	-5									-6						
FS-F-14	0.84	-6,-8	-8	-6	-6	-6	-5,-6						-8		-6				
FS-F-16	0.96		-10	-8	-8	-8			-6	-4									
FS-F-18	1.08	-10	-12	-8,-10	-10	-8			-8				-10		-8				
FS-F-20	1.21	-12		-12	-12	-10	-10		-10	-8			-12		-10	-10			
FS-F-22	1.34								-12										
FS-F-24	1.46	-16	-16		-16								-12	-16	-12	-12	-10	-10	6-6,6-8
FS-F-30	1.84	-24	-24						-16	-16			-16	-16	-20	-16	-16	-16	8-8
FS-F-38	2.34	-32	-32	-20,-24	-24				-20,-24	-20			-24	-24	-24	-24	-24	-24	
FS-F-40	2.46									-24									

Note: See Page D-26 for Firesleeve assembly instructions.



Accessory Selection Guide – Firesleeve (cont.)

A

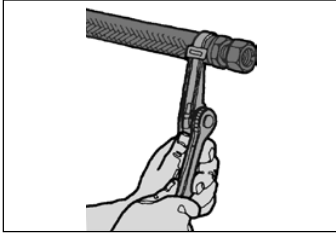

FSC Clamp

Used to attach firesleeve around socket on hose sizes with a 2" maximum O.D.

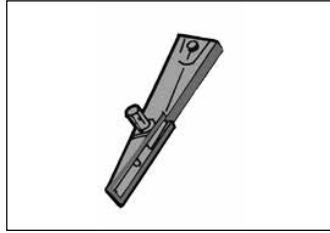

FST Clamp Tool

Part Number: FST-711617 Used to secure FSC clamp.



FSS Firesleeve Sealant

Keeps end of firesleeve from fraying - for neater, longer lasting installation.

B

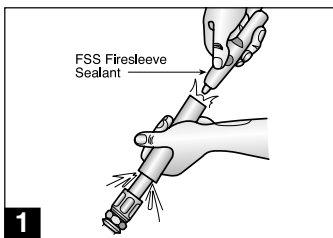

1

Firesleeve Assembly Instructions

1. Assemble one end fitting on hose. Cut firesleeve to same length as hose. Cover approximately 1" of each end of firesleeve with FSS sealant and allow to dry.
2. Push firesleeve back from cut end of hose and assemble the second end fitting. Then pull firesleeve completely over both sockets.
3. Insert tail of FSC clamp into FST clamping tool.
4. Position clamp around middle of socket and tighten with tool. Bend end of band back over buckle. Repeat on other end. Repair any scuffs or abrasions in firesleeve with FSS sealant.

C

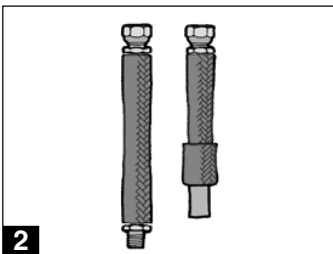

2

D

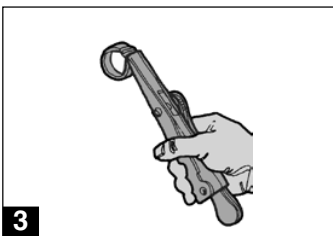

3

E

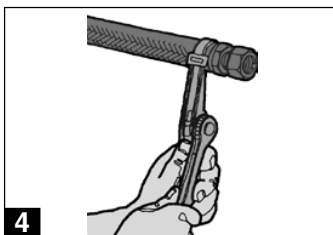

4

Accessory Selection Guide – CL Clamp

Vinyl coated steel clamps provide hose support where long lengths are used. Provides neater installation of hose lines, minimizes hose chafing and prevents damage to hose.

Material: CR Steel with Zinc Plating

Coating: Black Vinyl Plastisol - 0,8 mm (0.03 inch) thick.

Temperature Range: -40°C to +107°C (-40°F to +225°F).

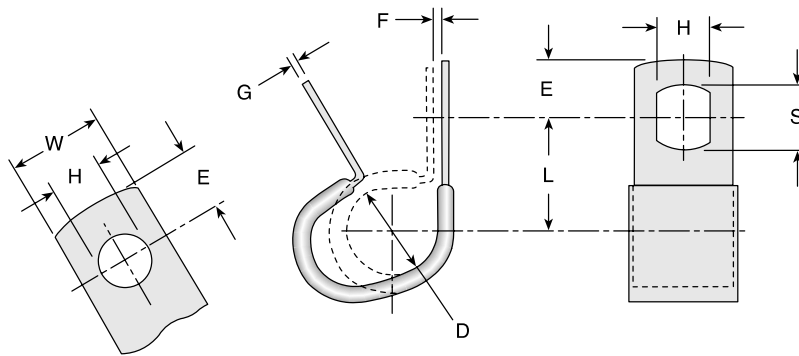

Part Number	D		H		L		W		E		F		G		S	
	±0,8 (mm)	±0.031 (inch)	±0,1 (mm)	±0.005 (inch)	±0,8 (mm)	±0.031 (inch)	±0,25 (mm)	±0.01 (inch)	±0,4 (mm)	±0.015 (inch)	±0,8 (mm)	±0.031 (inch)	±0,1 (mm)	±0.004 (inch)	±0,5 (mm)	±0.020 (inch)
CL-6	7,90	0.312	10,30	0.406	17,45	0.687	19,05	0.750	11,10	0.437	0,80	0.031	0,80	0.032	12,70	0.500
CL-7	9,50	0.375	10,30	0.406	18,25	0.718	19,05	0.750	11,10	0.437	1,55	0.062	0,80	0.032	12,70	0.500
CL-8+	11,10	0.437	10,30	0.406	19,05	0.750	19,05	0.750	11,10	0.437	1,55	0.062	1,20	0.048	12,70	0.500
CL-9	12,70	0.500	10,30	0.406	19,85	0.781	19,05	0.750	11,10	0.437	1,55	0.062	1,20	0.048	12,70	0.500
CL-10+	14,25	0.562	10,30	0.406	20,60	0.812	19,05	0.750	11,10	0.437	1,55	0.062	1,20	0.048	12,70	0.500
CL-11	15,90	0.625	10,30	0.406	21,40	0.843	19,05	0.750	11,10	0.437	1,55	0.062	1,20	0.048	12,70	0.500
CL-12	17,45	0.687	10,30	0.406	22,20	0.875	19,05	0.750	11,10	0.437	1,55	0.062	1,20	0.048	12,70	0.500
CL-13	19,05	0.750	10,30	0.406	23,00	0.906	19,05	0.750	11,10	0.437	1,55	0.062	1,20	0.048	12,70	0.500
CL-14	20,60	0.812	10,30	0.406	23,80	0.937	19,05	0.750	11,10	0.437	1,55	0.062	1,20	0.048	12,70	0.500
CL-15+	22,20	0.875	10,30	0.406	24,60	0.968	19,05	0.750	11,10	0.437	1,55	0.062	1,20	0.048	12,70	0.500
CL-16	23,80	0.937	10,30	0.406	25,40	1.000	19,05	0.750	11,10	0.437	1,55	0.062	1,20	0.048	12,70	0.500
CL-17	25,40	1.000	10,30	0.406	26,20	1.031	19,05	0.750	11,10	0.437	1,55	0.062	1,20	0.048	12,70	0.500
CL-18+	26,95	1.062	10,30	0.406	26,95	1.062	19,05	0.750	11,10	0.437	1,55	0.062	1,20	0.048	12,70	0.500
CL-19	28,60	1.125	10,30	0.406	27,75	1.093	19,05	0.750	11,10	0.437	1,55	0.062	1,20	0.048	12,70	0.500
CL-20+	30,20	1.188	13,50	0.531	31,75	1.250	25,40	1.000	14,25	0.562	1,55	0.062	1,20	0.048	15,90	0.625
CL-21	31,75	1.250	13,50	0.531	32,55	1.281	25,40	1.000	14,25	0.562	1,55	0.062	1,20	0.048	15,90	0.625
CL-22+	33,30	1.312	13,50	0.531	33,30	1.312	25,40	1.000	14,25	0.562	1,55	0.062	1,20	0.048	15,90	0.625
CL-23	34,90	1.375	13,50	0.531	34,10	1.343	25,40	1.000	14,25	0.562	1,55	0.062	1,20	0.048	15,90	0.625
CL-24+	36,50	1.437	13,50	0.531	34,90	1.375	25,40	1.000	14,25	0.562	1,55	0.062	1,20	0.048	15,90	0.625
CL-25	38,10	1.500	13,50	0.531	35,70	1.406	25,40	1.000	14,25	0.562	1,55	0.062	1,20	0.048	15,90	0.625
CL-26+	39,65	1.562	13,50	0.531	36,50	1.437	25,40	1.000	14,25	0.562	1,55	0.062	1,20	0.048	15,90	0.625
CL-27+	41,25	1.625	13,50	0.531	37,30	1.468	25,40	1.000	14,25	0.562	1,55	0.062	1,20	0.048	15,90	0.625
CL-29	44,45	1.750	13,50	0.531	38,90	1.531	25,40	1.000	14,25	0.562	1,55	0.062	1,20	0.048	15,90	0.625
CL-31+	47,65	1.875	13,50	0.531	40,45	1.593	25,40	1.000	14,25	0.562	1,55	0.062	1,20	0.048	15,90	0.625
CL-33	50,80	2.000	13,50	0.531	42,85	1.687	25,40	1.000	14,25	0.562	1,55	0.062	1,20	0.048	15,90	0.625
CL-36+	55,55	2.187	13,50	0.531	46,00	1.812	25,40	1.000	14,25	0.562	1,55	0.062	1,20	0.048	15,90	0.625
CL-37	57,15	2.250	13,50	0.531	46,00	1.812	25,40	1.000	14,25	0.562	1,55	0.062	1,20	0.048	15,90	0.625
CL-38+	58,70	2.312	13,50	0.531	49,20	1.937	25,40	1.000	14,25	0.562	1,55	0.062	1,20	0.048	15,90	0.625
CL-41+	63,50	2.500	13,50	0.531	50,80	2.000	25,40	1.000	14,25	0.562	1,55	0.062	1,20	0.048	15,90	0.625
CL-43	66,65	2.625	13,50	0.531	58,70	2.312	25,40	1.000	14,25	0.562	1,55	0.062	1,20	0.048	15,90	0.625

+Non-standard. Please contact Parker Hannifin Hose Products Division.



Accessory Selection Guide – HC, 88HC-H and 88DB Clamp

The Parker HC Clamp is a stainless steel worm gear clamp designed for low pressure industrial hose applications.

Material: Stainless steel

Specifications: SAE J1508, Type F and Type HD

HC Hose Clamp Table

Part Number	Size (SAE)	"A" Clamp Diameter			
		Minimum mm	inch	Maximum mm	inch
HC-6	-8	12	0.48	25	1.00
HC-8	-10	13	0.50	28	1.12
HC-10	-12	13	0.50	32	1.25
88HC-12	-16	19	0.75	38	1.50
88HC-16	-20	19	0.75	44	1.75
88HC-20	-24	25	1.00	51	2.00
88HC-24	-28	33	1.31	57	2.25

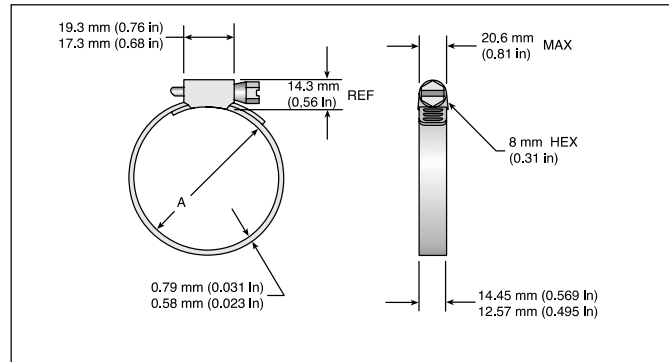

88HC-H

Series Hose Clamp
(High Torque Wormgear)

# Part Number	Hose I.D. inch
88HC-16C	3/4
88HC-16H	1
88HC-20H	1-1/4
88HC-24H	1-1/2
88HC-32H	2



Note: See 88 Series Assembly Instructions for proper 88HC-H clamp attachment.

88DB

Series Heavy Duty Hose Clamp
(Double Bolt Hose Clamp)

# Part Number	Hose I.D. inch
88DB-12	3/4
88DB-16	1
88DB-20	1-1/4
88DB-24	1-1/2
88DB-32	2

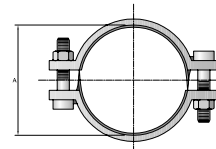

Accessory Selection Guide – Protection Shields (HP, HT, and HP-B)

Prevent hose abrasion while extending your hose life. Parker Hose Protection Shields extend hose life by protecting the hose from abrasion that occurs when hose rubs against other hose, metal or concrete. Parker hose shields are resistant to oil, lubricants, gasoline, most solvents and can withstand ambient temperatures from -40° to +300° F. Easily installed and secured by cable ties without disconnecting any hose lines. Use with hose from 1/4" to 2" I.D.

- ◆ Eliminate hose abrasion on concrete, metal or any rough surface.
- ◆ Guard against hose deterioration on mobile hydraulic equipment.
- ◆ Let Parker fill all your hydraulic and pneumatic hose product needs.

Hose Protector Shields are a fast and extremely cost effective way to isolate fluid lines from direct contact with other lines, components or structural members. They're available in 4-inch, 6-inch and 8-inch lengths and the width can be trimmed to satisfy a variety of situations.

These flexible protectors simply clamp around the hose and are securely held in place by nylon cable ties which are included. The cable ties are recessed in molded grooves to protect them from abrasion. **You don't need to disconnect a line to install a Parker Hose Protector Shield the way you do with a continuous tubular sleeve. Just wait until the installation is up and running to see exactly where contact needs to be prevented.**

Parker Hose Protector Shields are available in bulk quantities and in convenient assortments in 4", 6" and 8" sizes. Cable ties are included with all protectors and are also available in bulk.

Hose Shields

HP-B-13X18-KIT

2 ea. HP-B-13 RFL
2 ea. HP-B-15 RFL
4 ea. HP-B-18 RFL

Tie Wraps

HT-12-KIT
HT-16-KIT
HT-22-KIT

30 ea. HT-12 Tie Wraps
30 ea. HT-16 Tie Wraps
15 ea. HT-22 Tie Wraps

20 Hose Protectors and 60 Tie Wraps for each size are in point of purchase display box.

HP-B-13-RFL	10 ea. HP-B-13 Hose Protectors (4"). 30 ea. HT-12 Tie Wraps in a sealed plastic bag.
HP-B-15-RFL	10 ea. HP-B-15 Hose Protectors (6"). 30 ea. HT-16 Tie Wraps in a sealed plastic bag.
HP-B-18-RFL	5 ea. HP-B-18 Hose Protectors (8"). 15 ea. HT-22 Tie Wraps in a sealed plastic bag.

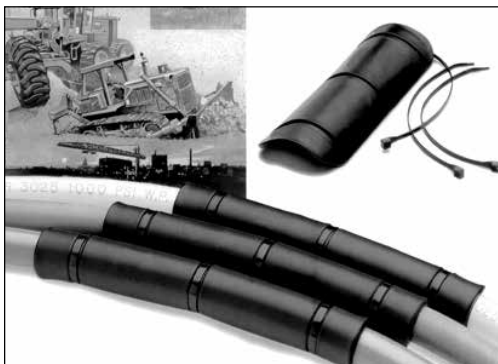

Contact your authorized Parker Hose Products Distributor for pricing and delivery information.

Note: Parker Hose Protector Shield products are intended to prevent damage. They are not suitable as patches or repairs for lines which are already damaged or worn beyond safe use standards.



HPD Hose Assembly Workstations

Hose Products Division has set up an agreement to enable our customers to purchase directly from our vendor, Safety Step.

<p>Safety Step's contact information is:</p>	<p>Safety Step Jeff Lewis 888-448-4237 jlewis@safetystep.net</p>
---	--

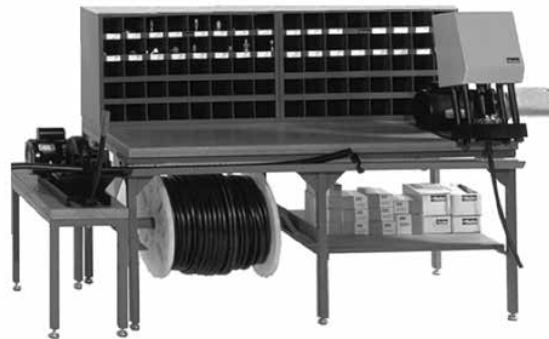

The complete on-site complete hose assembly workstation design (above) includes:

- TH7-5-C—6' table with 1 hose reel and 1 bottom shelf
- TH7-6—16 hose reel system, with rotating base
- TH7-7—15" wide table set up for Parker 239 or 339 Cut-Off Saw

- (2) 40B-Cabinet 40 openings - 4-1/2" x 4-1/2" x 12" in size
- TH7-6-C—Optional overhead crane
- TH7-5-HT—Optional 6' measured hose trough with adjustable hose stop

Specifications: HoseFab Table (heavy duty)

- Laminated wood table top
- 1-1/2" square tubing structure
- Gussetted corner braces
- 6-leg design
- All legs have adjustable feet
- Hose reel/shelf combinations
- 40B-Cabinet or 72B-Cabinet for fitting storage
- *Optional: Hose trough for measurement of hose*
 - Calibrated to line up to Saw Table
 - Adjustable stop for standard length cuts
 - Built-in tape measure

Specifications: Rotary Reel Rack (TH7-6)

- 16 Hose reel capacity
- Compact design
- Rotates for 1 man use
- Center post bolts to floor in 4 places
- Optional: Overhead crane

Specifications: Saw Table (TH7-7)

- Calibrated to line up to Hose trough
- Adjustable feet
- Mounts to 6-foot bench

Specifications: 3 or 4 Reel Rack

- Free standing 3 reel rack (TH7-8)
- Bolts to floor
- Optional: 4th reel capacity with wall mounts (TH7-8-F)



Pictured left is a complete on-site hose assembly workstation, the Parker Kart:

The **Parker Kart, TH7-4**, is a portable all-in-one unit designed to hold a Minikrimp, Karrykrimp, Karrykrimp 2, or Parkrimp 1; a 332T-115V Cut-off Saw; 4 reels of hose; and has a 40 bin cabinet with 3 drawers for tools. The TH7-4 can be customized to fit your specific hose assembly needs. Contact Parker HPD or your Parker Hose distributor for details.

Note: Part number TH7-4 does not include hose, fittings or equipment.

See Safety Step contact information at the top of this page

Note: Part number and specifications of components for both workstations are listed on the following pages.



HoseFab Table

Features

Heavy duty constructed table for mounting Minikrimp, Karrykrimp, Karrykrimp 2, or Parkrimp 1. HoseFab Table is available in 3 versions to meet your requirements. Options include two 40B-Cabinets or 72B-Cabinets for fitting storage.

Part Number	Description
TH7-5-R	6' table with 2 hose reels
TH7-5-S	6' table with 2 bottom shelves
TH7-5-C	6' table with 1 hose reel and 1 bottom shelf
TH7-5-HT	Optional 6' measured hose trough with adjustable hose stop
40B-Cabinet	40 openings - 4-1/2" x 4-1/2" x 12" in size
72B-Cabinet	72 openings - 4-1/2" x 4-1/2" x 12" in size

Table measurements:

Height - 31-3/4"
Width - 29"
Length - 72"

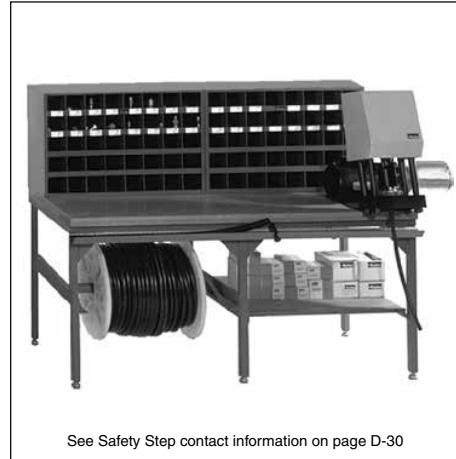

See Safety Step contact information on page D-30

Rotary Reel Rack

Features

16 Hose reel capacity that fits in a compact area. Supplied with heavy duty casters which allow for ease of turning, even when fully loaded. Optional overhead crane available.

Part Number	Description
TH7-6	16 hose reel system, with rotating base
TH7-6-C	Optional overhead crane

Rack measurements:

Height - 104" (120" with optional overhead crane)
Width - 67"
Length - 67"

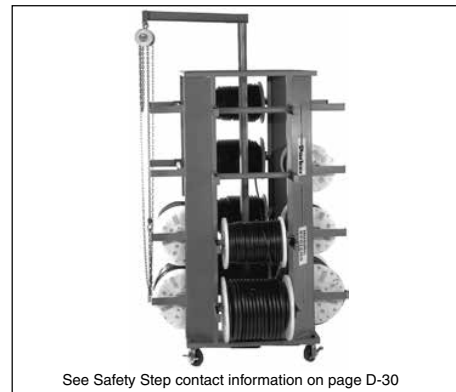

See Safety Step contact information on page D-30

Saw Table

Features

The Saw Table, specially designed for Parker 239 or 339 Hose Cut-Off Saw, attaches directly to the HoseFab Table.

Part Number	Description
TH7-7	15" wide table set up for Parker 239 or 339 Cut-Off Saw

Table measurements:

Height - 18"
Width - 28"
Length - 14"



See Safety Step contact information on page D-30

3/4 Reel Rack

Features

Compact in its design, the standard version will hold 3 reels of hose. Optional 4th reel capacity designed with wall anchor mounts.

Part Number	Description
TH7-8	Upright 3 hose reel rack
TH7-8-F	Optional extension with wall anchor for 4th reel

Rack measurements:

Height - 59" (82-1/2" with 4th reel option)
Width - 27-3/4"
Length - 27-1/2"



See Safety Step contact information on page D-30

A

B

C

D

E

A



See Safety Step contact information on page D-30

Parker Kart Part No. TH7-4

Parker Kart organizes and stores all your necessary Parker hoses, fittings, power and hand tools - everything you need to make fast hose assemblies on site. As a valued addition to any facility, Parker Kart will save on downtime and labor costs, as well as eliminate errors in cutting and fitting attachment. With Parker Kart, you'll always have the materials you need, right when and where you need them.

- Easy one-man movement
- Eight-inch urethane casters with brakes
- Forklift carry tubes
- Electric receptacle with cord
- Fitting bins and drawers
- Large tool drawer
- Four hose reel holders
- Choice of Parker crimping equipment
- Optional accessories available

Parker Kart can be customized to fit specific hose assembly needs. Parker Kart does not include hose, fittings or equipment.

B

C

D

E



Fitting Stock Bins 72B-Cabinet

36" wide, 43" high, 12" deep, with 72 openings each 4-1/2" x 4-1/2" x 12", heavy duty steel, all welded construction. Product bin labels are available.



Hose Stock Bins HR6-Hose-Bin

Rugged metal cabinet for stocking coils of Parker hose 36" wide, 28" high, 20" deep, with upright separators to provide 6 compartments varying in width from 4" to 8".

Provides suitable base on which to place the fittings stock bin (top measures 36" x 20", bottom of fittings bin measures 36" x 12".)

Yellow with black "Parker Hose" lettering.